

T.D. 1

Les bascules

Exercice 1 : Bascules RS

1. Complétez le chronogramme du circuit ci-dessous. Si l'on considère la totalité de ce circuit comme une seule bascule RS, quel est son mode de synchronisation ?

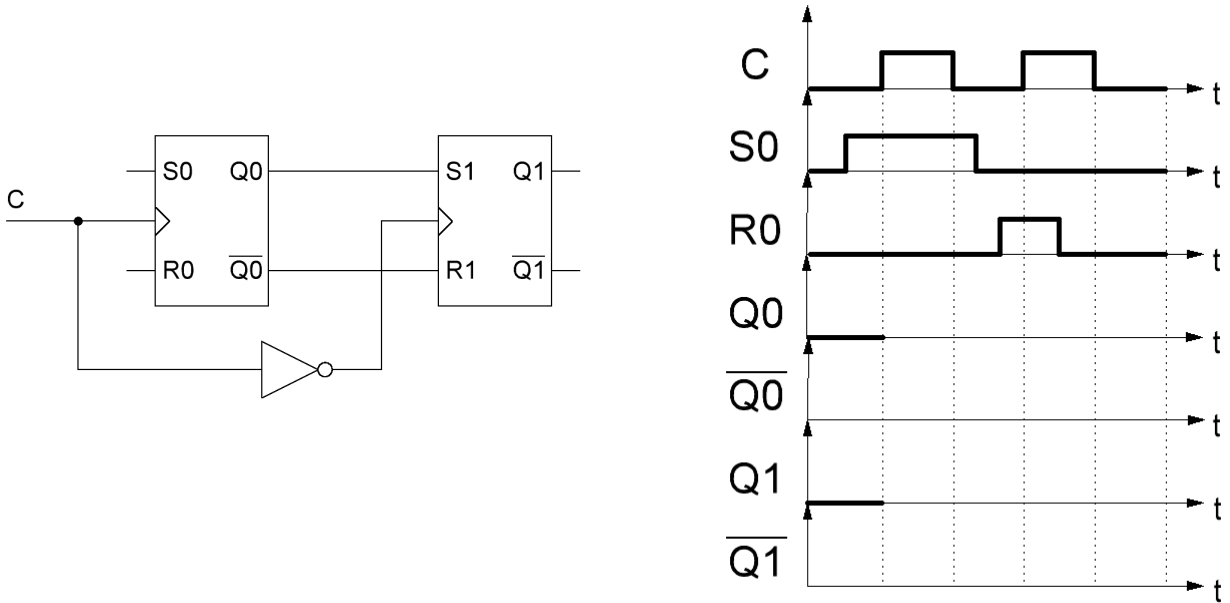

2. Complétez les chronogrammes suivants selon que la bascule RS est synchronisée sur état haut ($Q0$), sur front montant ($Q1$), sur front descendant ($Q2$) et sur impulsion ($Q3$).

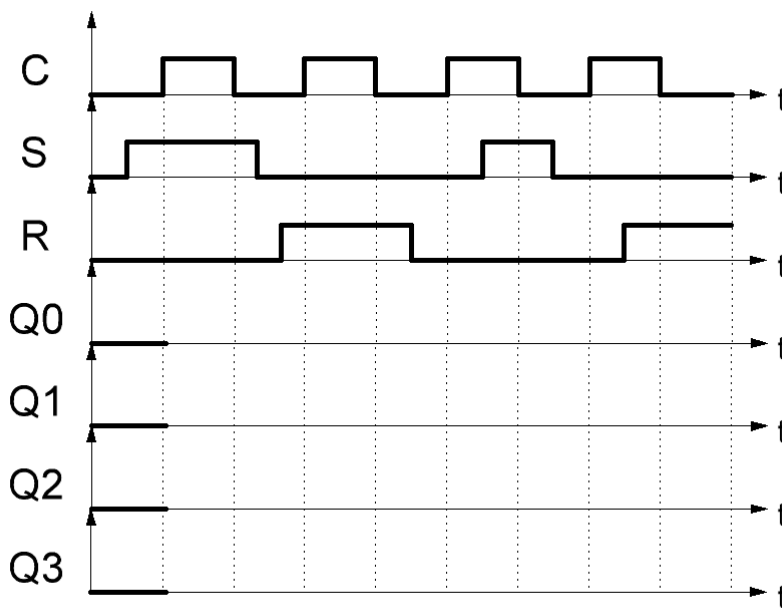

3. Tracez le chronogramme de la sortie Q pour chacun des deux circuits ci-dessous. Dans le premier circuit, quel est le rapport entre la fréquence de Q et celle de C ? Comment appelle-t-on ce montage ?

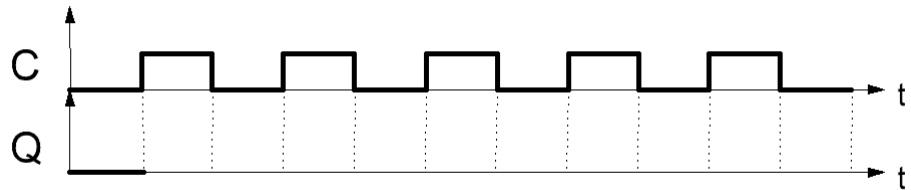
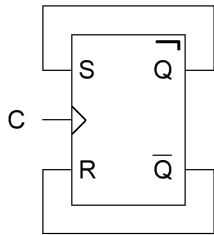
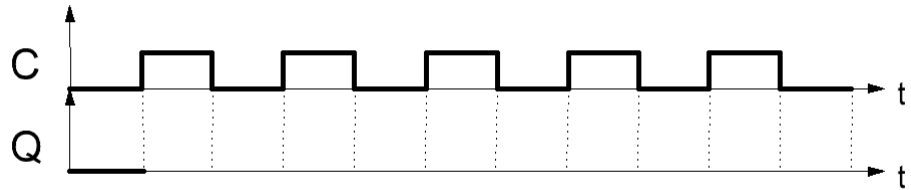
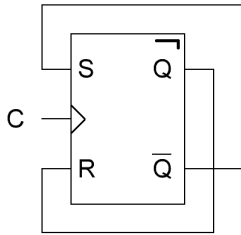

4. Complétez les chronogrammes des circuits ci-dessous.

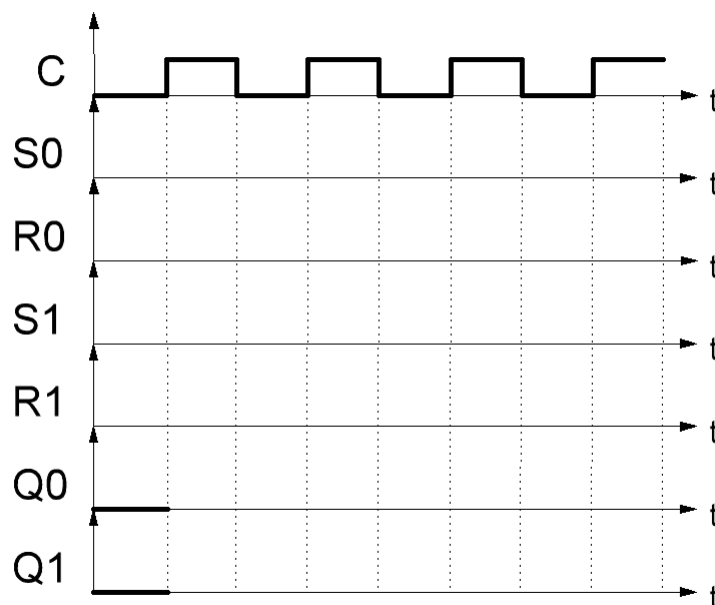
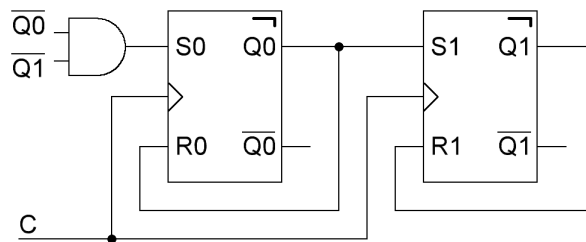

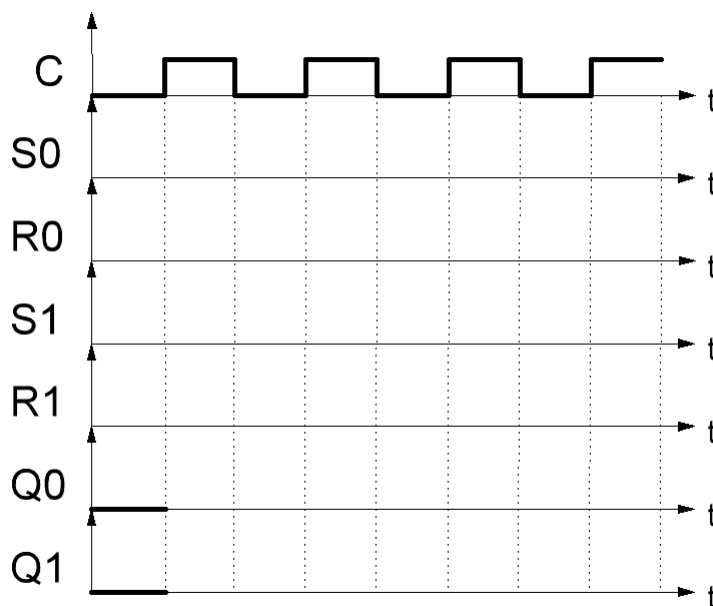
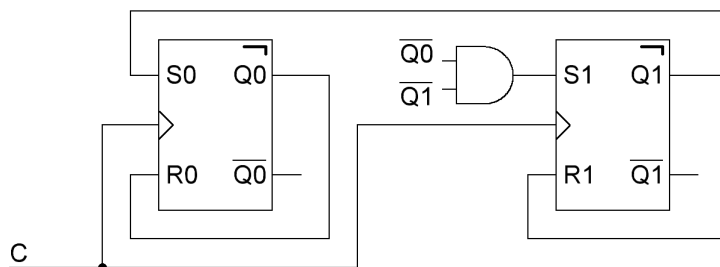
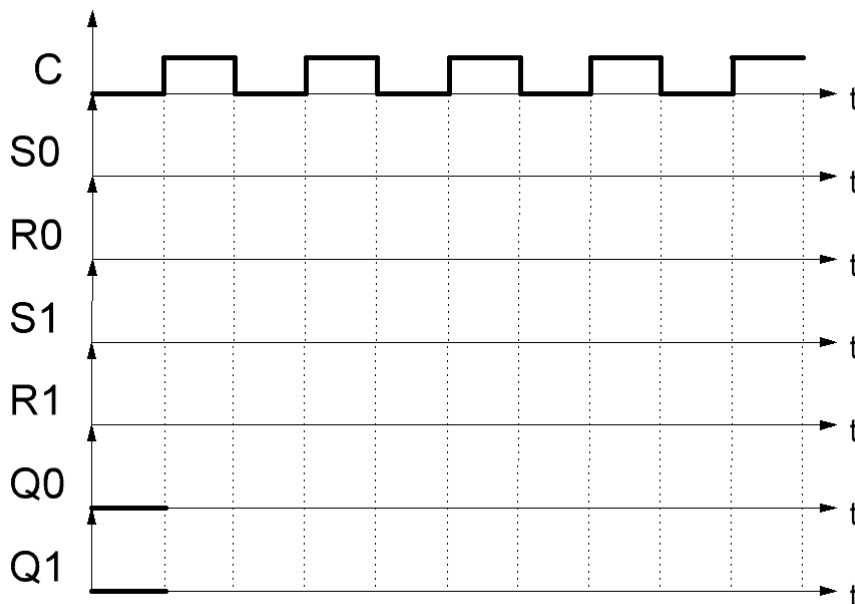
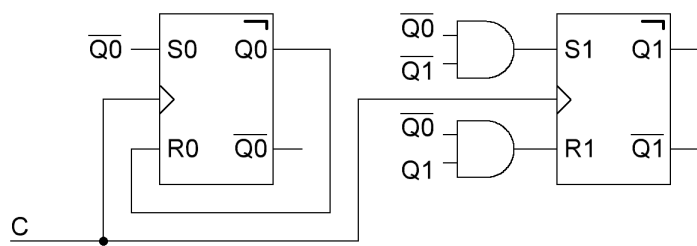

Exercice 2 : Bascules D

1. Complétez les chronogrammes suivants selon que la bascule D est synchronisée sur état haut ($Q0$), sur front montant ($Q1$), sur front descendant ($Q2$) et sur impulsion ($Q3$).

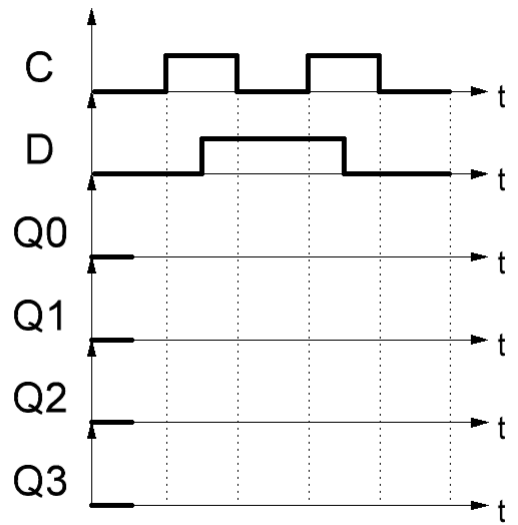
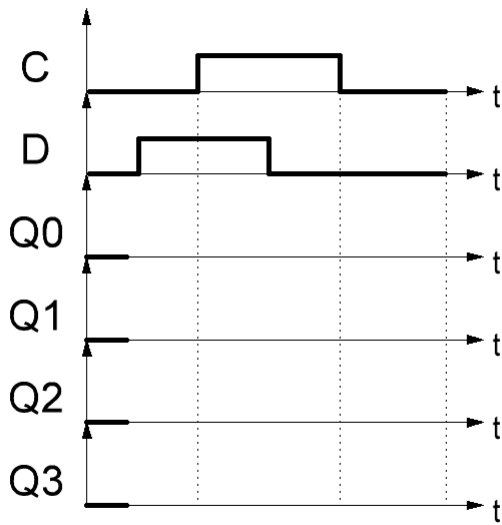

2. Tracez le chronogramme de la sortie Q pour chacun des deux circuits ci-dessous.

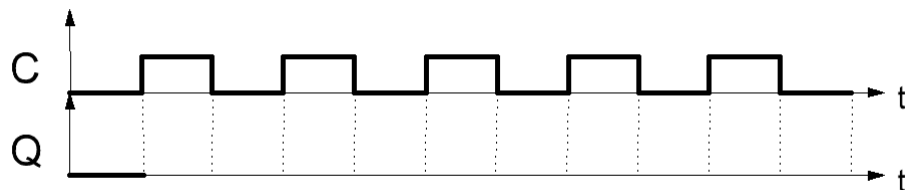
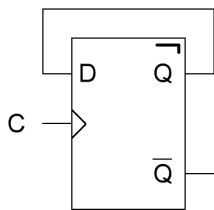
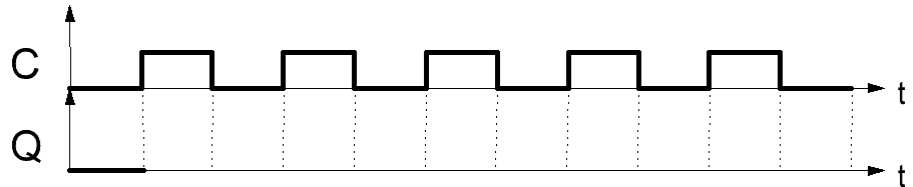
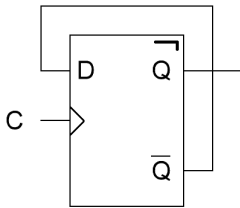

3. Complétez le chronogramme du circuit suivant.

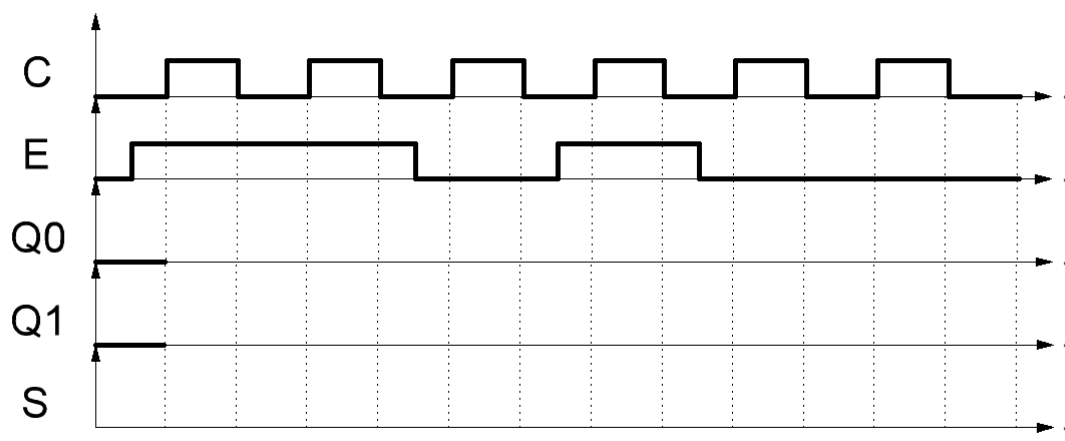
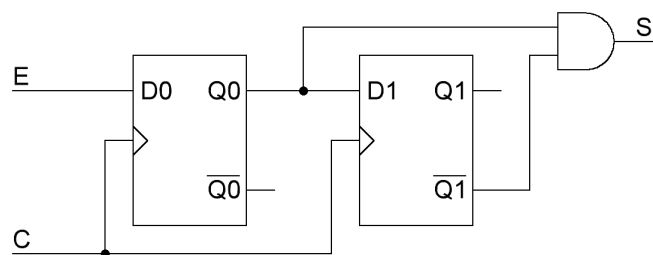

4. Complétez les chronogrammes des circuits ci-dessous.

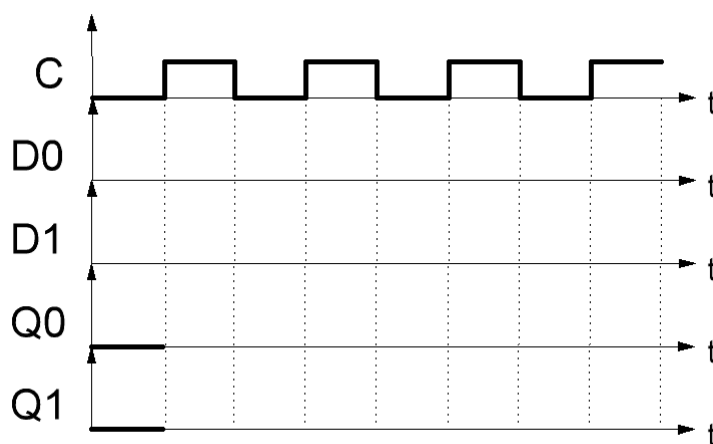
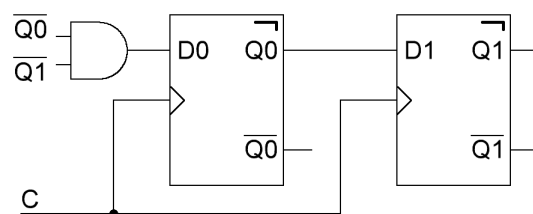

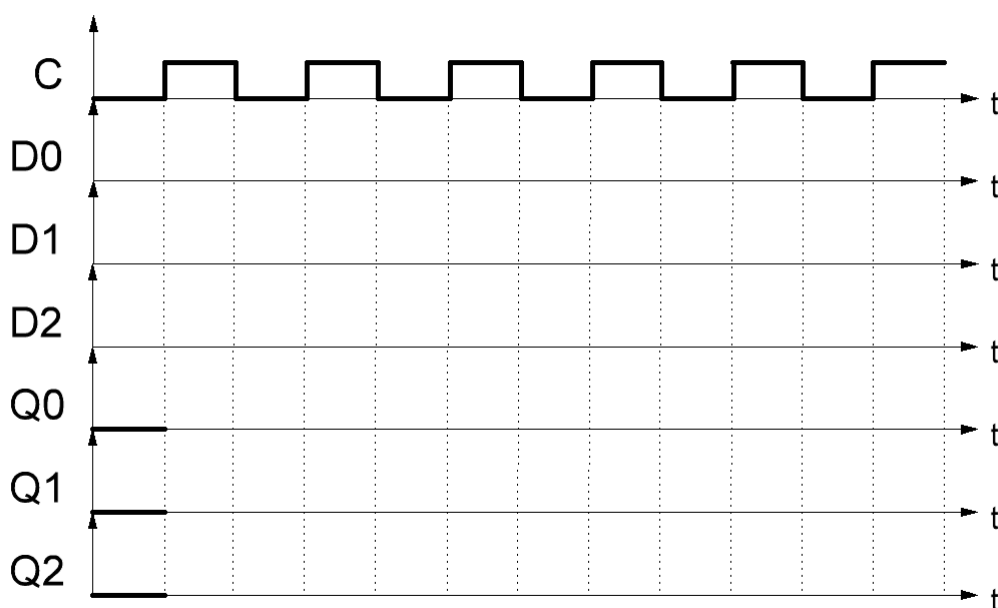
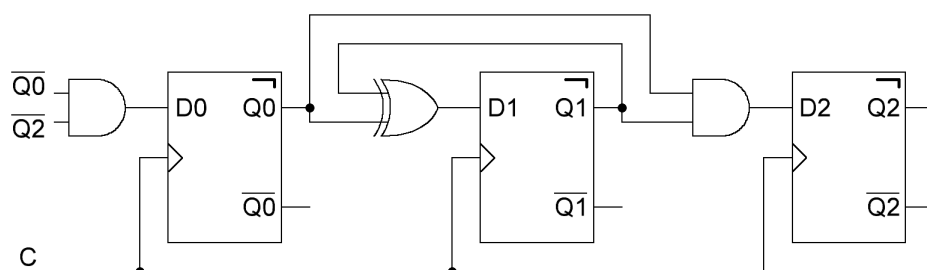
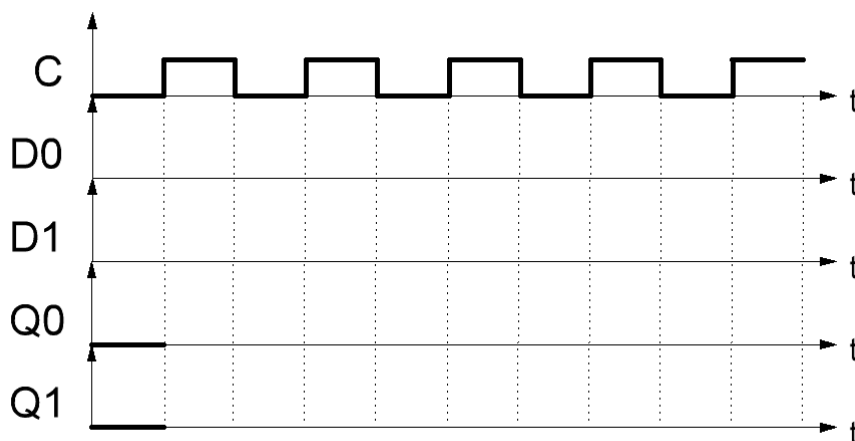
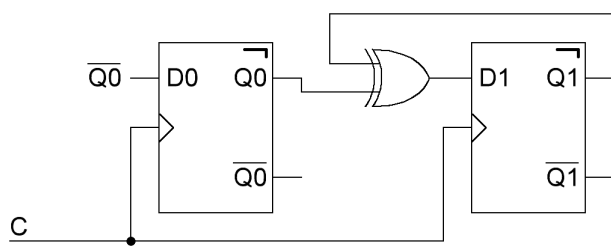

Exercice 3 : Bascules JK

1. Complétez les chronogrammes suivants selon que la bascule JK est synchronisée sur front montant ($Q0$), sur front descendant ($Q1$) et sur impulsion ($Q2$).

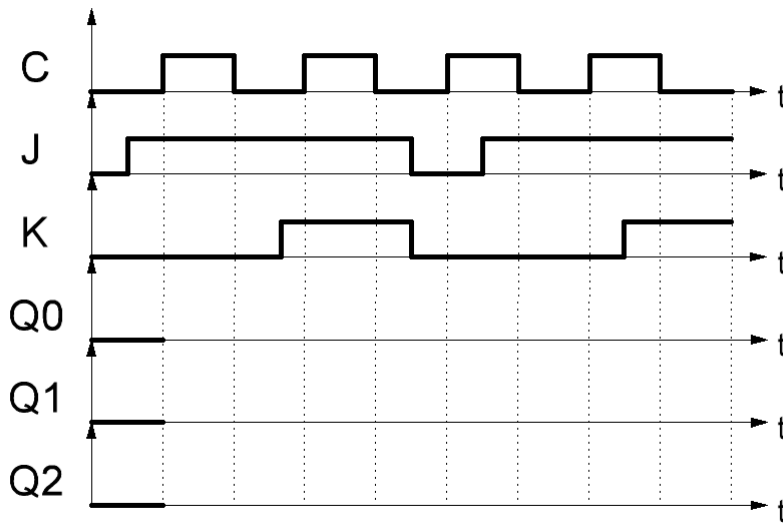

2. Tracez le chronogramme de la sortie Q pour chacun des deux circuits ci-dessous. Quel est le rapport entre la fréquence de Q et celle de C ? Comment appelle-t-on ces montages ? Trouvez une autre façon d'obtenir le même rapport entre ces deux fréquences.

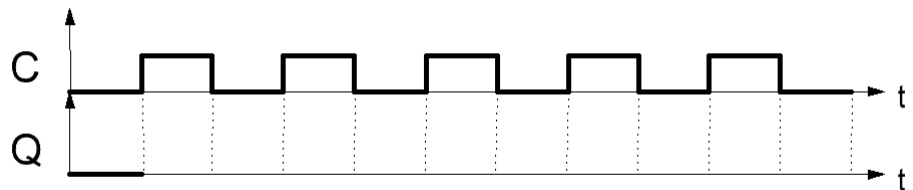
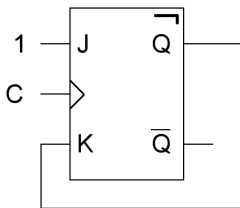
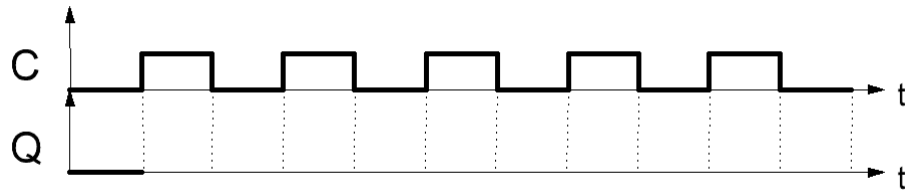
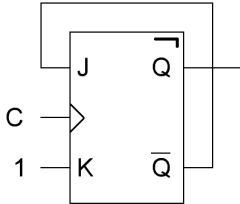

3. Complétez les chronogrammes des circuits ci-dessous.

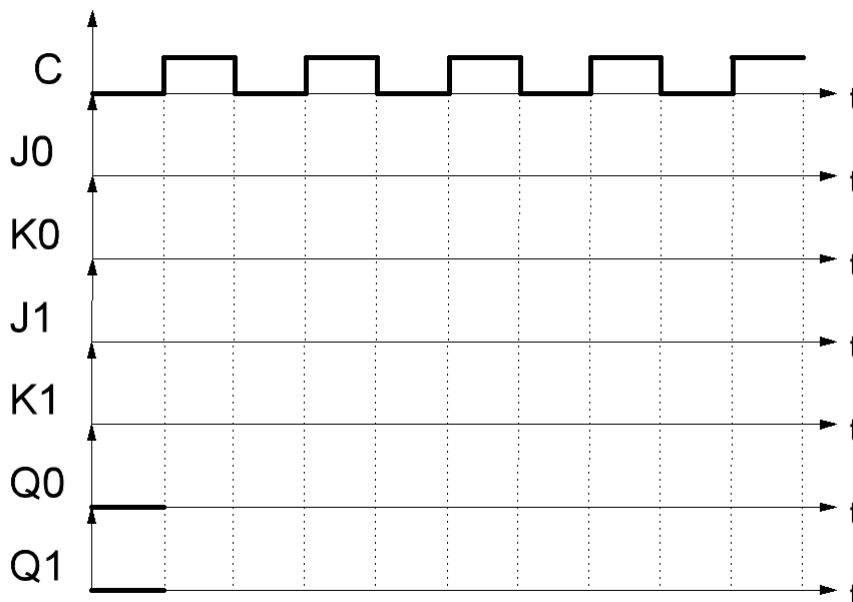
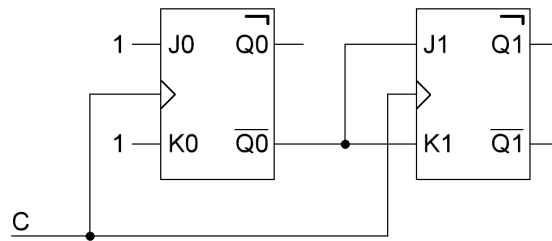
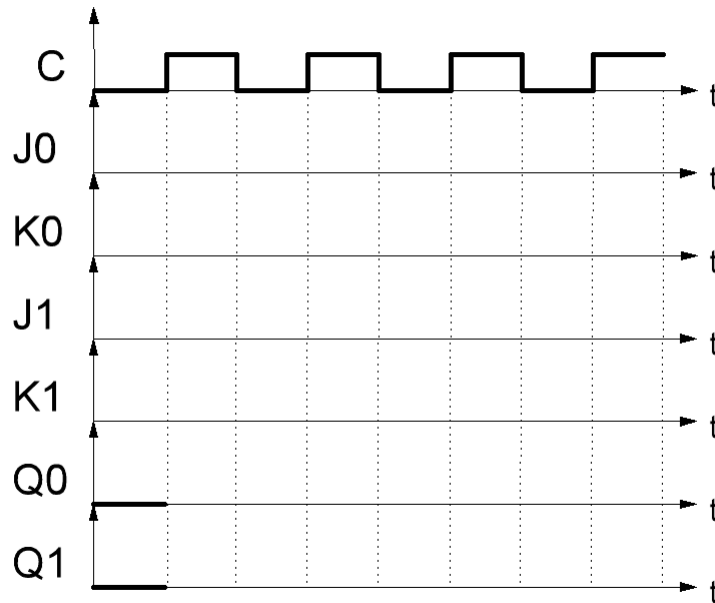
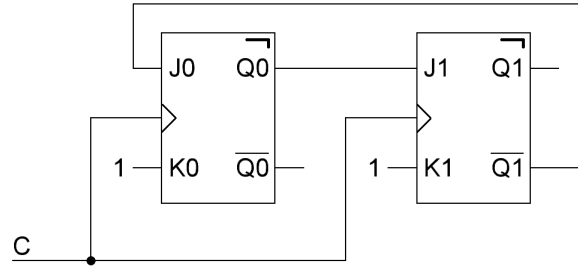

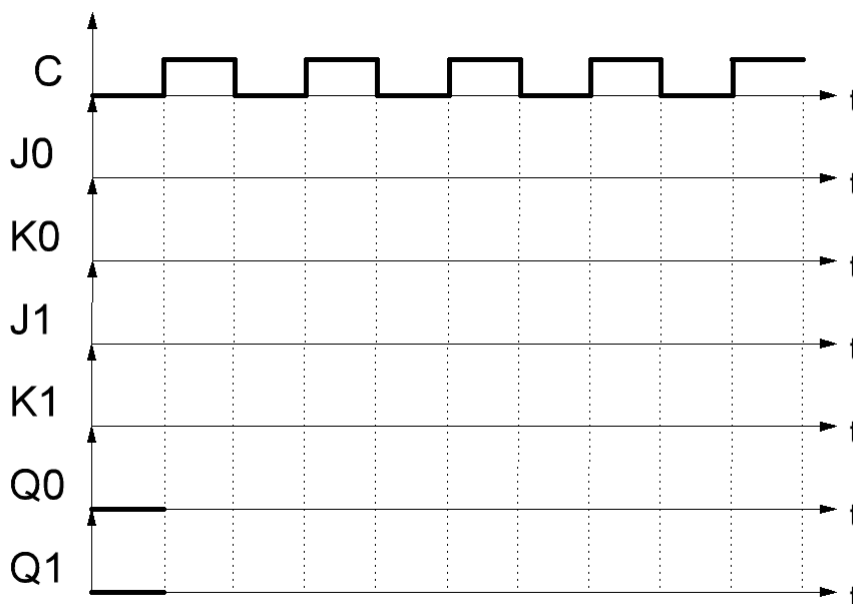
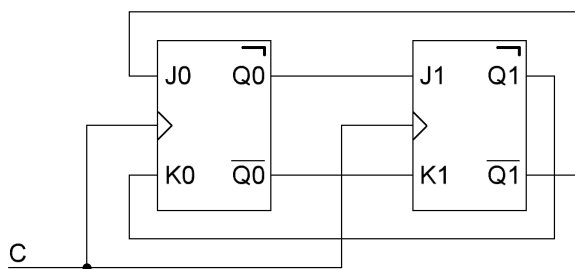

4. Complétez le chronogramme du circuit ci-dessous.

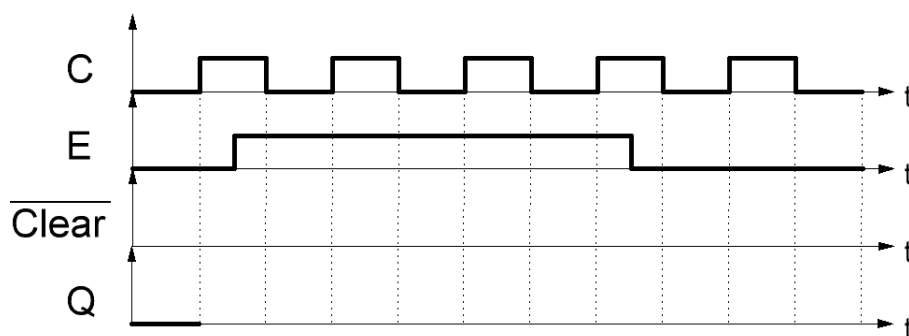
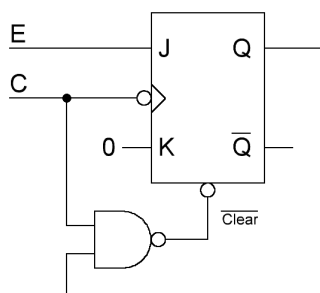

5. Complétez le chronogramme du circuit ci-dessous.

